

**Ambassador
Junior
International
240V**

Model: C45014-02

OPERATION

SERVICE

PARTS

CARE

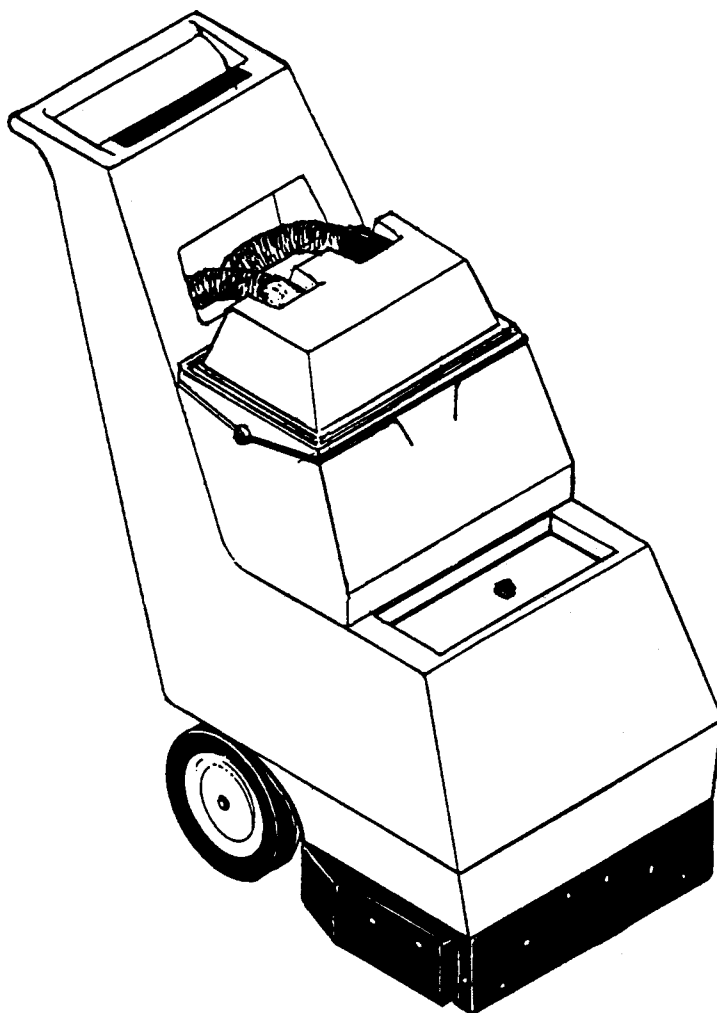

Revised 6/02

Minuteman[®]

FOR COMMERCIAL USE ONLY

IMPORTANT SAFETY INSTRUCTIONS

When using an electrical appliance, basic precautions should always be followed, including the following:

READ ALL INSTRUCTIONS BEFORE USING

WARNING - To reduce the risk of fire, electric shock, or injury:

- Do not leave appliance when plugged in. Unplug from outlet when not in use and before servicing.

WARNING

To reduce the risk of electrical shock, do not expose to rain. Store indoors.

- Do not allow to be used as a toy. Close attention is necessary when used by or near children.
- Use only as described in this manual. Use only manufacturer's recommended attachments.
- Do not use with damaged cord or plug. If appliance is not working as it should, has been dropped, damaged, left outdoors, or dropped into water, return it to a service center.
- Do not pull or carry by cord, use cord as a handle, close a door on cord, or pull cord around sharp edges or corners. Do not run appliance over cord. Keep cord away from heated surfaces.
- Do not unplug by pulling on cord. To unplug, grasp the plug, not the cord.
- Do not handle plug or appliance with wet hands.
- Do not put any object into openings. Do not use with any opening blocked; keep free of dust, lint, hair, and anything that may reduce air flow.
- Keep hair, loose clothing, fingers, and all parts of body away from openings and moving parts.
- Do not pick up anything that is burning or smoking, such as cigarettes, matches, or hot ashes.
- Do not use without dust-bag and/or filters in place.
- Turn off all controls before unplugging.
- Use extra care when cleaning on stairs.
- Do not use to pick up flammable or combustible liquids such as gasoline or use in areas where they may be present.
- Connect to a properly grounded outlet only. See grounding instructions.

SAVE THESE INSTRUCTIONS

INSPECTION

Carefully unpack and inspect your machine for shipping damage. Each unit is tested and thoroughly inspected before shipment, and any damage is the responsibility of the delivery carrier who should be notified immediately.

ELECTRICAL

This machine is designed to operate on a standard 16 amp. type L fused 230 volt, 50 hz, AC circuit. Voltages below 200 volts AC or above 250 volts AC could cause serious damage to the motor. I.E.C. Class 1.

WARNING

Electric motors can cause explosions when operated near explosive materials or vapors. Do not operate this machine near flammable materials such as solvents, thinners, fuels, grain dust, etc.

GROUNDING INSTRUCTIONS

This appliance must be grounded. If it should malfunction or breakdown, grounding provides a path of least resistance for electric current to reduce the risk of electric shock. This appliance is equipped with a cord having an equipment-grounding conductor and grounding plug. The plug must be plugged into an appropriate outlet that is properly installed and grounded in accordance with all local codes and ordinances.

DANGER

Improper connection of the equipment-grounding conductor can result in a risk of electric shock. Check with a qualified electrician or service person if you are in doubt as to whether the outlet is properly grounded. Do not modify the plug provided with the appliance — if it will not fit the outlet, have a proper outlet installed by a qualified electrician.

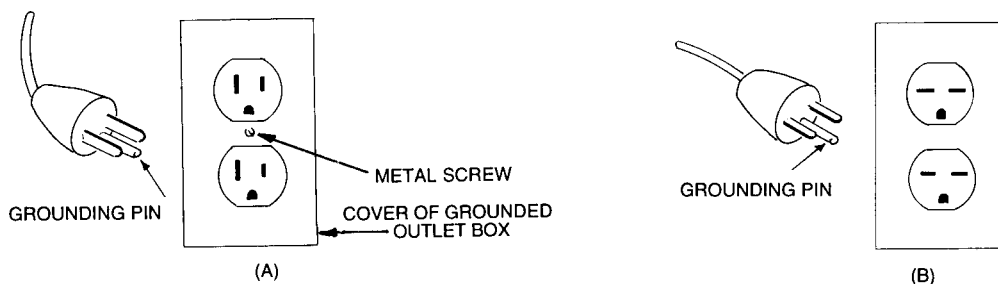

USER MAINTENANCE INSTRUCTIONS

All service and repair should be performed by qualified vacuum service representative or electrician. No user serviceable components are employed in the electrical system. No lubrication of the motor is required.

DAILY MAINTENANCE

1. Solution tank should be emptied after each use. Flush pumping system with 2 or 3 gallons of clean hot water.
2. Check and clean vacuum inlet filter (page 7, item 116) and solution inlet strainer (page 7, item 40) daily.
3. Removable recovery tank, page 7, item 8, should be rinsed clean daily.
4. Spray jets should be checked for correct spray pattern and cleaned if plugged (page 7, item 123). Spray jets are quick release 1/4 turn type. By twisting item 121 1/4 turn counter clockwise, jets can be removed for cleaning. Do not clean out spray tips with pins or wire, this may cause damage to the jet spray pattern and cause streaking.
5. Protect equipment from freezing. Severe pumping system damage can occur if allowed to freeze.
6. Inspect vacuum hoses for tight connections. Check electrical cable for abrasion or cuts in jacket. Cord should be replaced if worn or damaged.

MONTHLY/BI-MONTHLY MAINTENANCE

The Ambassador Solution Pump System should be purged twice monthly to remove alkaline residue build-up. The system should be flushed twice, once with the jets installed and once with jets removed. To flush system out, use 1 quart of white vinegar to two gallons of clean hot water, followed by a clear 2 gallon rinse. Clean spray jets if required.

CORD STORAGE

While not in use storage can be accomplished by winding cord around rear of machine. Cord hooks are provided.

- Do not use with damaged cord or plug. If appliance is not working as it should, has been dropped, damaged, left outdoors, or dropped into water, return to service center.
- Do not pull or carry by cord, use cord as handle, close a door on cord, or pull cord around sharp edges or corners. Do not run appliance over cord. Keep cord away from heated surfaces.
- Do not unplug by pulling cord. To unplug, grasp the plug, not the cord.
- Do not handle plug or appliance with wet hands.

This equipment should be stored indoors and not exposed to rain.

OPERATING INSTRUCTIONS

FILLING THE AMBASSADOR

Remove clear solution cover lid from front of machine, page 7, item 50. Fill solution tank with desired amount of warm water and add liquid cleaning chemical, Minuteman Extraction Shampoo order #902163. (See instructions on container for proper dilutions.) DO NOT USE powdered cleaning chemicals. Powders are unlikely to dissolve thoroughly, resulting in clogging the inline solution strainer. This can reduce or stop solution flow to the pump and spray jets.

Carpet should be thoroughly vacuumed and obstacles relocated before beginning the cleaning cycle. Heavy traffic lane areas should be pre-treated or spotted with Minuteman Pre-Treat order #902183 for best results.

TO BEGIN CLEANING:

1. Always work away from the cord.
2. Machine operates by pulling backwards over carpet.
3. Vacuum Lid Assembly (page 7) should be properly seated on Recovery Tank (item 8) for proper vacuum recover. See figure 3 for hose hookup.
4. See page 5, Control Panel Switch Identifications:
Normal Cleaning Mode
 1. Turn on vacuum switch (1).
 2. Turn on brush switch (2).
 3. Turn on pump switch to continuous (3).
 4. Adjust brush pressure (figure 2) at rear of machine, until brush pressure gauge reads in green zone.
 5. Solution pump should be turned off to the center switch position, page 5 (4), 6" before the end of each cleaning pass.

During the cleaning cycle, care should be taken not to allow foam to build up in the recovery tank. If this should happen, the machine should be turned off. Defoamer order #910543 should be added to the recovery tank only, never into the solution tank. Foam should not be allowed to enter vacuum filter screen.

The recovery waste water level can be viewed from the operator's position of the machine through the visible recovery dome. When waste water is within 2" of the top of the recovery tank, the tank should be emptied. (NOTE : Never tilt machine completely back with recovery tank in place. Always remove tank and set to the side before tilting complete machine.) Recovery tank can be emptied by lifting visible recovery dome and lifting out tank by front handle. A handle gripping area is provided in the front bottom of the recovery tank to tilt and pour the waste water out.

AUXILIARY TOOL HOOK UP

1. Remove grey hose fitting from clear recovery dome and install auxiliary hose assembly cuff to grey fitting by passing through rear of machine. Hook up solution hose to auxiliary out coupler at rear of machine.
2. Turn vacuum switch to on.
3. Turn pump auxiliary switch to on (page 5, item 6). All other switches should be off.

OPERATOR VIEW OF CONTROL PANELS

1. Vacuum switch
2. Brush switch
3. Pump spray switch, continuous operation position. Pump supplies solution to spray bar for cleaning in large open areas.
4. Center position is "off".
5. Momentary position is for intermittent spray for cleaning in smaller more confined areas. When released, switch will return to center off position.
6. Pump auxiliary when using separated floor tool or upholstery tool, switch must be switched to on position. See figure 2 for solution hose hook up - aux. out.
7. Brush pressure adjustment gauge.

See figure 2 for brush adjustment knob location. Adjustments past the green zone on gauge will shorten brush and brush drive motor life.

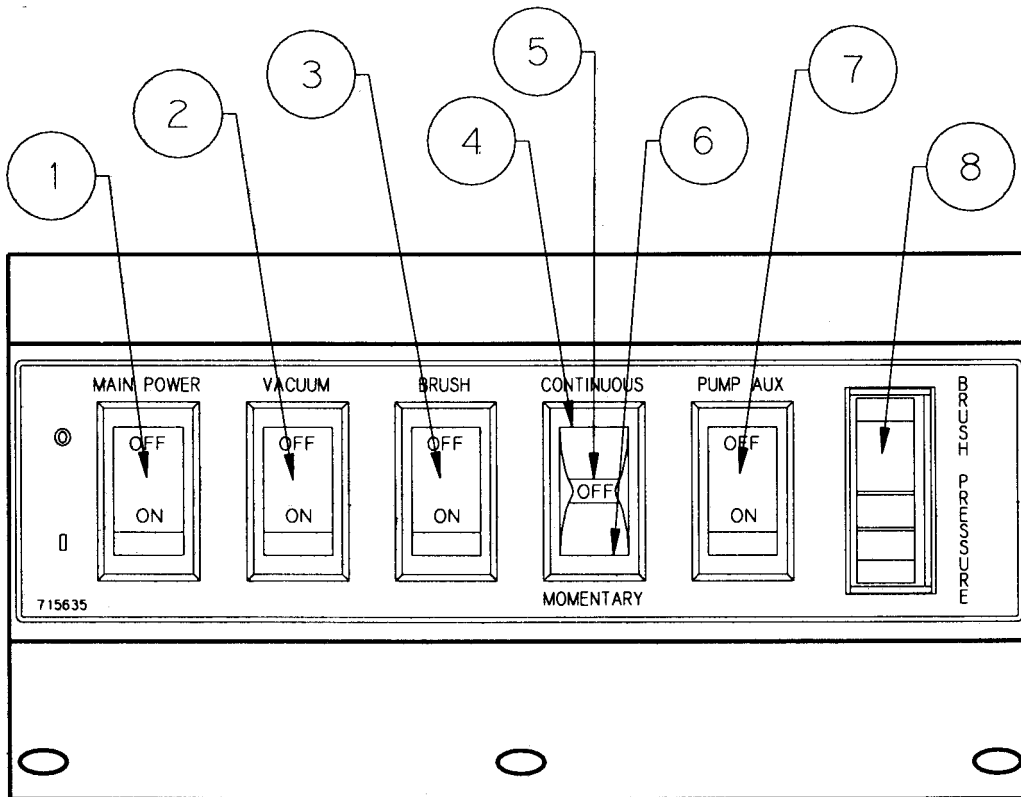

FIG. 1

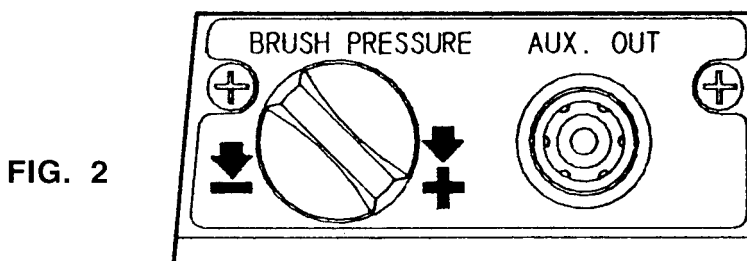
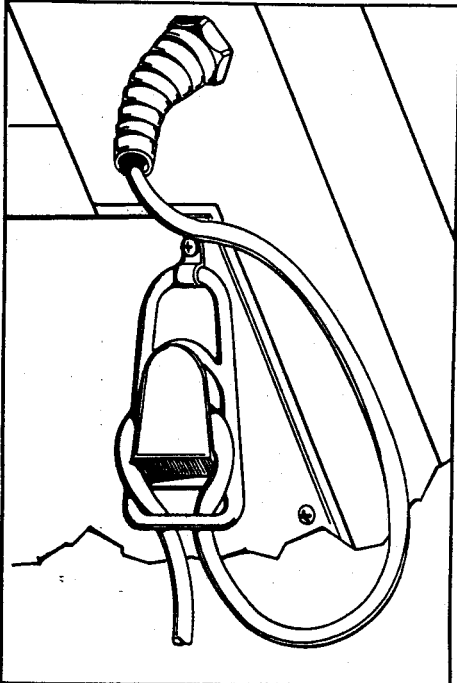
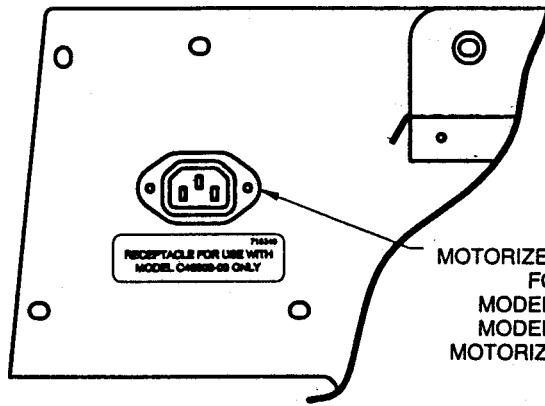

FIG. 2

CORD STRAIN RELIEF



PARTIAL VIEW BACK PANEL



MOTORIZED TOOL RECEPTACLE
FOR USE WITH
MODEL C46300-00 (120V)
MODEL C46300-02 (240V)
MOTORIZED TOOL USE ONLY!

OPERATOR VIEW VISIBLE RECOVERY SYSTEM

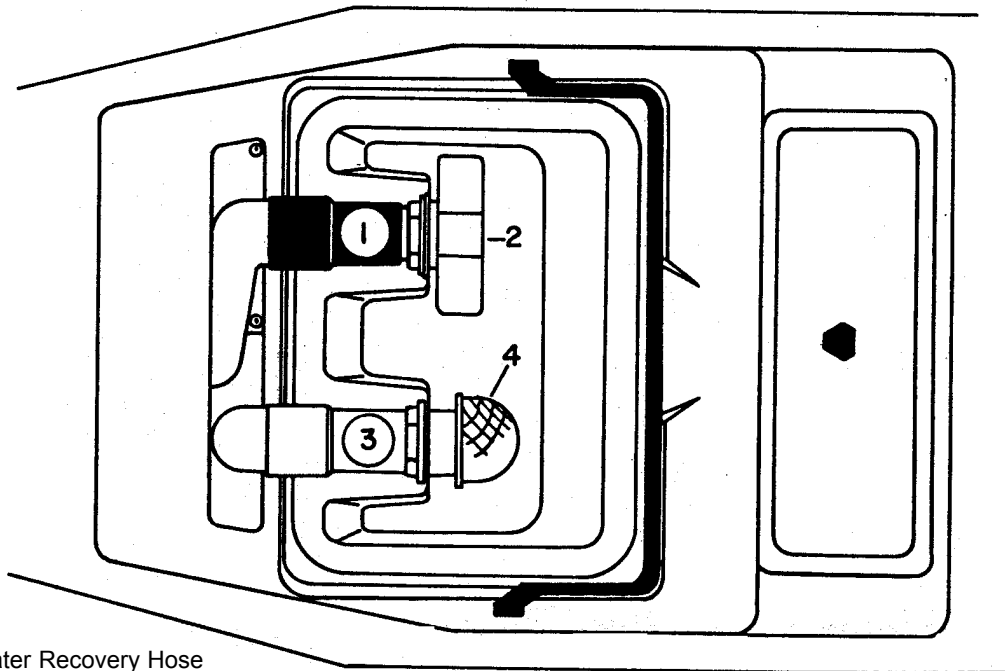
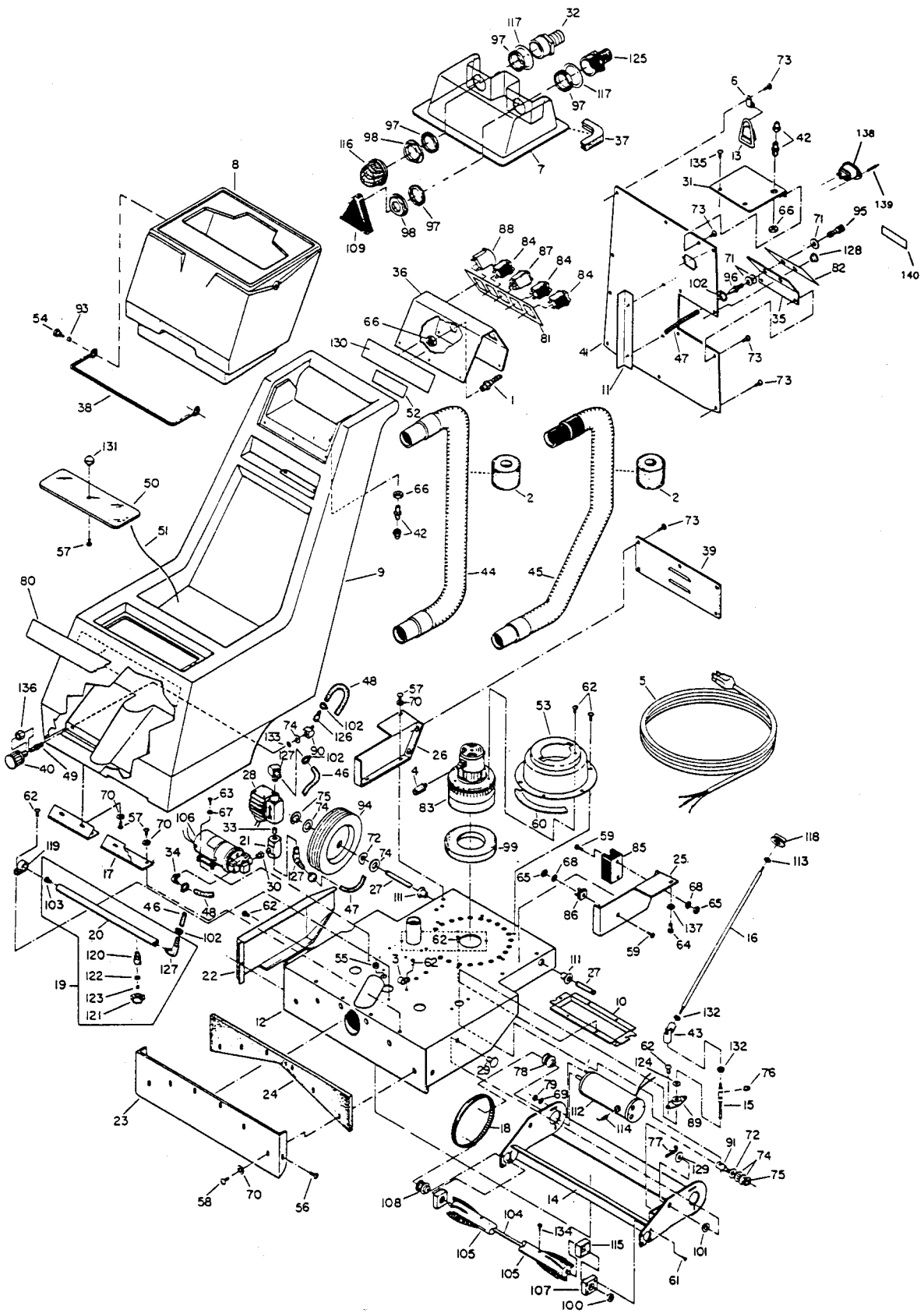

FIG. 3

1. Waste Water Recovery Hose
(Grey hose cuff to grey fitting)
2. Recovery Waste Water Diffuser
3. Vac Hose White Cuff
(White hose cuff to white fitting)
4. Vac Filter Screen



PARTS LIST

ITEM	PART NO.	QTY.	DESCRIPTION	ITEM	PART NO.	QTY.	DESCRIPTION
1	150004	1	Strain Relief	71			No Longer Used
2	169125	2	Filter	72			No Longer Used
3	250038	1	Retainer, Bag Clip	73	712101	19	SCR-MC HWSR 10-24 x .375 SS
4	380028	2	Carbon Brush Replacement	74	711594	11	WSR-Flat .56 x .88 x .02 NI
5	740600	1	Cord Set 16-3 50'	75	711713	3	Retaining Ring - E Ext. .50
6	381052	1	Clamp Plastic 3/8 ID	76	711717	2	Retaining Ring - E Ext. .37
7	450102	1	Recovery Dome Amb Jr	77	711808	2	Cotter Pin - Hair No. 13
8	450101	1	Recovery Tank Amb Jr	78	833443	1	HTD Flanged Pulley
9	450100MCH	1	Solution Tank Amb Jr Mch	79	711427	2	Nut-Flanged Wizz 10-32
10	450104	1	Vacuum Air Manifold	80	715385	1	Decal "Minuteman"
11	450109	1	L Bracket Back	81	715132	1	Decal Diecut SC17
12	450106	1	Mainframe Weldment	82	715133	1	Decal Brush Adjustment Ambassador
13	450012	1	Cord Strain Relief	83	740244	1	Vac Motor 2 Stage 230V
14	450113	1	Brush Bracket Weldment Jr	84	809754	3	Switch Rocker
15	450019	1	Adj. Rod Brush	85	740189	1	Terminal Block
16	452010	1	Flexible Cable Assembly	86	740203	1	Rectifier
17	450112	2	Hinge	87	740400	1	Momentary Switch
18	450022	1	Belt	88	740229	1	Gauge Pressure
19	450116	1	Spray Tube Assy 3 Jet Comp	89	450068	1	Bearing, Flange Mounted
20	450117	1	Spray Tube	90	833906	1	1/4 Street Brass
21	450119	1	Male Branch T 1/4 Brass	91	762257	1	Nut, Adjusting RH Zinc
22	450026	1	Belt Guard	92			No Longer Used
23	450110	1	Front Squeegee Plate	93	762384	2	Bushing SS .277 x .375 x .37
24	450118	1	Front Plate Gasket	94	900008	2	Wheel 8 In.
25	450030	1	Wheel Well Plate - RH	95	828370	1	BH2-60 Female Coupler
26	450031	1	Wheel Well Plate - LH	96	828952	2	3/8 Barb x 1/4 MPT
27	450111	1	Axle Rear Amb Jr	97	828970	4	WSR Neop 1.87 x 2.4 x .125
28	740240	1	Water Solenoid 230V	98	828971	2	Nut 1 1/2 Pipe Thread
29	450034	2	Clevis Pin	99	828995	1	Gasket Neop 2.5 x 6 x .62
30	830708	1	Bushing BR 3/8 MPT x 1/4 FPT	100	829044	2	Bearing
31	450036	1	Cover Top	101	829052	2	Flanged Bushing
32	450083	1	Insert Fitting	102	829129	2	Hose Clamp Micro-Seal
33	828981	1	Brass Nipple 1/4	103	829619	1	Hex Head Pipe Plug 1/4 BR
34	450040	1	Elbow PLT 3/8 MPT x 3/8 Barb	104	450052	1	Brush Shaft Amb. Jr
35	450065	1	Quick Disconnect Bracket	105	450121	1	Brush Core Amb. Jr
36	450043	1	Dashboard	106	742150	1	Pump 230V Bypass
37	450044	1	Molded Rec Dome Gasket	107	829758	2	Bearing Block
38	450120PTD	1	Handle Recovery Tank Amb	108	829823	2	Pulley HTD Flanged 30T
39	450064	1	Lower Rear Panel	109	830448	1	Deflector
40	130118	1	Solution Strainer	110			No Longer Used
41	450063	1	Rear Panel Assy Amb Jr	111	831212	2	Flange Bearing
42	450050	2	Heyco Bushing Liquid Tight	112	833458	1	Motor Brush 1/8 HP 230V
43			No Longer Used	113			No Longer Used
44	450053	1	Vac Hose Assy. White	114	831429	1	Brush Repl (2 per Set)
45	450090	1	Vac Recovery Hose Clear	115	831610	2	Brush Shield
46	450055	2	Hose Spraybar C/L 9"	116	831621	1	Suction Line Strainer
47	450056	1	Hose Nylobraid C/L 21"	117	450081	2	WSR-SS
48	450057	1	Solution Hose C/L 20-1/2"	118	452029	1	Knob 5/16-18
49	450059	1	Brass Bulkhead Fitting	119			No Longer Used
50	450066	1	Solution Tank Cover	120	833140	3	Body Inlet Connector
51	450062	1	Cord Nylon	121	833141	3	Cap
52			No Longer Used	122	833142	3	Gasket, Cap
53	450074PLT	1	Motor Shroud Zinc Plated	123	450122	3	Unijet Spray Tip 6503
54	500033	2	Locking Screw	124	711523	1	WSR-Wave
55	700287	1	Grommet	125	450082	1	Adapter 1.5 x 1.5
56	712565	2	SCR-MC 1/4-20 x .50 ST PL	126	833473	1	Hose Barb 1/4 FPT x 3/8 Barb
57	712560	8	SCR-MCH 1/4-20 x .50 SS NYL	127	833325	3	Hose Barb Elbow
58	710180	6	SCR-MC 1/4-20 x .75 ST PL	128			No Longer Used
59	710207	3	SCR-MC 6-32 x .87 ST PL	129	711506	2	WSR-Flat 5/16 ST PL
60	805042	1	Gasket	130			No Longer Used
61	710528	8	SCR-MC 8-32 x .37 BR	131	833214	1	Knob 3-Sided
62	711124	15	SCR-ST-B 10 x .37 NI	132	711420	2	Nut-Hex Jam 5/16-18 ST PL
63	711126	4	SCR-ST-B 10 x .75	133	832326	1	O Ring
64	711202	2	BLT-HH 1/4-20 x .50 ST PL	134	710130	2	SCR-MC 8-32 x 1/2
65	711301	3	Nut-Hex 6-32 ST PL	135	711104	2	SCR-ST-A 10 x .50
66	711400	2	Nut-Pipe Lock 1/2	136	829114	1	Adapter BR 3/8 FPT x 1/4 FPT
67	711503	4	WSR-Flat No. 10	137	711544	2	WSR-Helical .1/4
68	711552	3	WSR-Internal Lock #8	138	741038	1	Receptacle
69	711553	7	WSR-Internal Lock No. 10	139	410-4419AA	2	Pop Rivet
70	711554	14	WSR-Internal Lock 1/4 ID	140	715340	1	Decal

RECEPTACLE IEC 320
741038

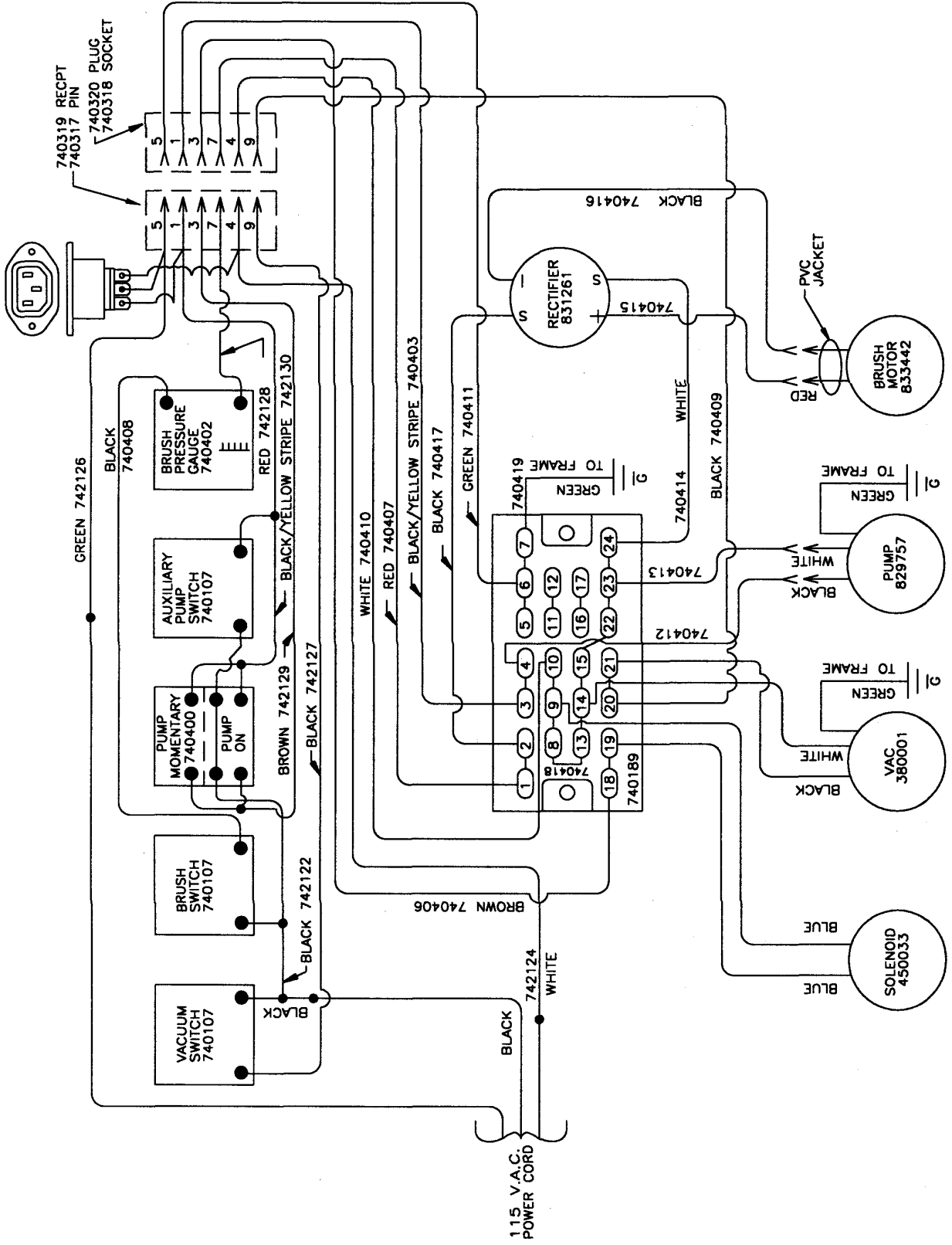

RECOMMENDED CARPET CARE CHEMICALS

<p>Extraction Shampoo A highly concentrated low-foaming product. Contains detergents, emulsifiers, water-soluble solvents and optical brighteners for effective use in all types of carpet extraction equipment.</p>	<p>Product # 902163</p>	<p>Bro-Go A mild acid formulation that removes browning or yellow discoloration on carpet due to excessive build-up of old shampoos.</p>	<p>Product # 902133</p>
<p>Pre-Treat A synthetic cleaner formulation used as a pre-spray to help speed the cleaning action of the shampoo process. Use for bonnet cleaning and also as an effective spotter.</p>	<p>902183</p>	<p>Take Charge An effective, safe long lasting product designed to eliminate troublesome static electricity from carpet.</p>	<p>910033</p>
<p>Take-Out An enzyme detergent spotter that dissolves protein carbohydrates, cellulose, vegetable oils, greases and both human and pet urine stains.</p>	<p>902198</p>	<p>Karpetreet II™ Contains DuPont "Teflon" carpet protector. A water-based, concentrated fluoro-chemical which forms a protective coating that inhibits resoiling of carpet.</p>	<p>902153</p>
<p>Carpet Spotter A water-based spotter which contains organic solvents for use on spots created by material such as grease, tar and crayons</p>	<p>910673</p>	<p>SpinShield Cleans and provides oil stain repellency to carpets in one step when spin-bonnet cleaning.</p>	<p>902073</p>
<p>Defoamer A silicone-based defoamer for use in any cleaning equipment which generates foam.</p>	<p>910543</p>	<p>ExtracShield An effective detergent system formulated with an optical brightener and carpet fiber protectant for use with hot water extraction equipment.</p>	<p>902063</p>
<p>Odor-Out A concentrated water-based deodorant additive that can be sprayed, mopped or wiped on any surface that is not harmed by water.</p>	<p>902143</p>	<p>Carpet Spotting Kit Contains five specialized carpet spot removers formulated to remove a wide assortment of stains from commercial and institutional carpeting. An easy to follow, color coded spotting guide simplifies effective spot removal with step-by-step instructions.</p>	<p>902000</p>

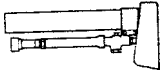
		Part No.	Description
A		828924	Hose Assembly
B		831255	Scrub Wand
C		390070	Stair & Upholstery Tool

LIMITED WARRANTY

Minuteman International, Inc. warrants to the original purchaser/user that this product is free from defects in workmanship and materials under normal use and service for a period of three years from date of purchase. In addition, Minuteman International, Inc. will, at its option, honor labor warranty claims for the first 12 months from date of sale, provided such claims are submitted through and approved by factory authorized repair stations. Minuteman International, Inc. will, at its option, repair or replace without charge, except for transportation costs, parts that fail under normal use and service when operated and maintained in accordance with the applicable operation and instruction manuals.

This warranty does not apply to normal wear, or to items whose life is dependent on their use and care, such as belts, cords, switches, hoses, rubber parts, electrical motor components or adjustments. Parts not manufactured by Minuteman International, Inc. such as engines, batteries, battery chargers, hydraulic pumps, and tires are covered by and subject to the warranties and/or guarantees of their manufacturers. Please contact Minuteman International, Inc. for procedures in warranty claims against these manufacturers.

Special warning to purchaser — Use of replacement filters and/or prefilters not manufactured by Minuteman International, Inc. or its designated licensees, will void all warranties expressed or implied.

A potential health hazard exists without exact original equipment replacement.

All warranted items become the sole property of Minuteman International, Inc. or its original manufacturer, whichever the case may be.

Minuteman International, Inc. disclaims any implied warranty, including the warranty of merchantability and the warranty of fitness for a particular purpose. Minuteman International, Inc. assumes no responsibility for any special, incidental or consequential damages.

This limited warranty is applicable only in the U.S.A. and Canada, and is extended only to the original user/purchaser of this product. Customers outside the U.S.A. and Canada should contact their local distributor for export warranty policies. Minuteman International, Inc. is not responsible for costs or repairs performed by persons other than those specifically authorized by Minuteman International, Inc. This warranty does not apply to damage from transportation, alterations by unauthorized persons, misuse or abuse of the equipment, use of non-compatible chemicals, or damage to property, or loss of income due to malfunctions of the product.

If a difficulty develops with this machine, you should contact the dealer from whom it was purchased.

This warranty gives you specific legal rights, and you may have other rights which vary from state to state. Some states do not allow the exclusion or limitation of special, incidental or consequential damages, or limitations on how long an implied warranty lasts, so the above exclusions and limitations may not apply to you.

Minuteman[®]

World Headquarters
Minuteman International, Inc.
111 South Rohlwing Road
Addison, Illinois 60101

Minuteman Canada, Inc.
2210 Drew Road
Mississauga, Ontario
L5S 1B1

(630) 627-6900
FAX (630) 627-1130

(905) 673-3222
FAX (905) 673-5161

985808-I
Printed in U.S.A.